



2022



OHSAS18001

ISO9001

ISO14001

SINOMEMB®



I.	SINOMEMB®	7
		7
		7
	VIP	7
II.	SINOMEMB®	8
		8
		8
		8
		8
III.	SINOMEMB®	9
IV.	SINOMEMB®	9
VI.	SINOMEMB®	10
	SINOMEMB®	15
		16
	SINOMEMB®	SNLE 16
1.1		 16
1.2		 17
1.3		 17
1.4		 17
	SINOMEMB®	SNBW 19
2.1		 19
2.2		 19
2.3		 19
2.4		 19
2.5		 20
	SINOMEMB®	SNBW-FR 22
3.1		 22
3.2		 22
3.3		 22
3.4		 23
3.5		 23
	SINOMEMB®	SNBW-XFR 25
4.1		 25
4.2		 25
4.3		 25



4.4	25
4.5	26
SINOMEMB®	SNBW-440Por	27
5.1	27
5.2	27
5.3	27
5.4	27
5.5	28
SINOMEMB®	SNHW	29
6.1	29
6.2	29
6.3	29
6.4	30
SINOMEMB®	SNNF	31
7.1	31
7.2	31
7.3	31
7.4	32
7.5	32
SINOMEMB®	SNSW	34
8.1	34
8.2	34
8.3	34
8.4	35
8.5	35
	37
SINOMEMB®	SNLE	37
1.1	37
1.2	37
1.3	38
1.4	38
1.5	39
SINOMEMB®	SNSE	42
2.1	42
2.2	42
2.3	42
2.4	43



	SINOMEMB®	SNLE	45
3.1			45
3.2			45
3.3			45
3.4			45
3.5			46
			47
3.1			47
3.2			47
3.3			49
3.4			49
3.5			50
			52
4.1			52
4.2			52
4.3			56
4.4			58
4.5			61
4.6			63
4.7			63
4.8			63
			64
5.1			64
5.2			65
5.3			69
5.4	SINOMEMB®		72
5.5			72
			75
6.1			75
6.2			77
6.3			81
			84
7.1	RO/NF		84
7.2			85
7.3			87
7.4			88



7.5	88
7.6	88
7.7	91
7.8	92
7.9	93
7.10	95
	97
8.1	97
8.2	97
8.3	100
8.4	103
SINOMEMB®	105
9.1	105
9.2	105
SINOMEMB®	TFC.....	107

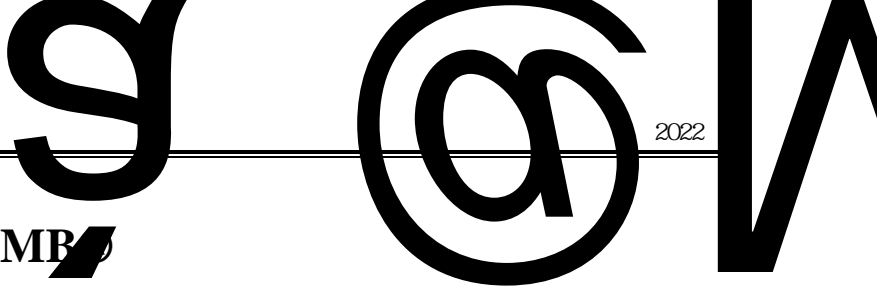

I. SINOMEMB

SINOMEMB®

SINOMEMB®

VIP

SINOMEMB®



II. SINOMEMB®



III. SINOMEMB®

——SNLE	(Low Energy)
——SNBW	(Brackish Water)
——SNSE	(Save electricity)
——SNNF	(Nano Filtration)
——SNSW	(Sea Water)
——SNHW	(high-concentration-salt water)

IV. SINOMEMB®

——FR——	(Fouling Resistant)
——XFR——	(XSTR Fouling Resistant)
——HF——	(High Flux)
——HR——	(High Rejection)



VI. SINOMEMB®

SNBW-8040-FR400/34

SN BW 80 40 FR 400 / 34





& SNLE-1812-50

SN LE - 18 12 - 50

以加仑/天 (GPD) 单位表示的产水量

50(50GPD); 75(75GPD);
100(100GPD) ; 200(200GPD);
300(300GPD); 400(400GPD)

以英寸为单位的膜元件长度: 12 英寸

以英寸为单位的膜元件直径(英寸)





• SINOMEMB®

(RO) (NF)

SINOMEMB®

SN-BW	
SN-BW-HF	
SN-BW-Por	
SN-BW-FR	
SN-BW-XFR	
SN-LE	
SN-LE-HF	
SN-SE	
SN-NF90	
SN-NF270	
SN-HW	()
SN-SW	



SINOMEMB®

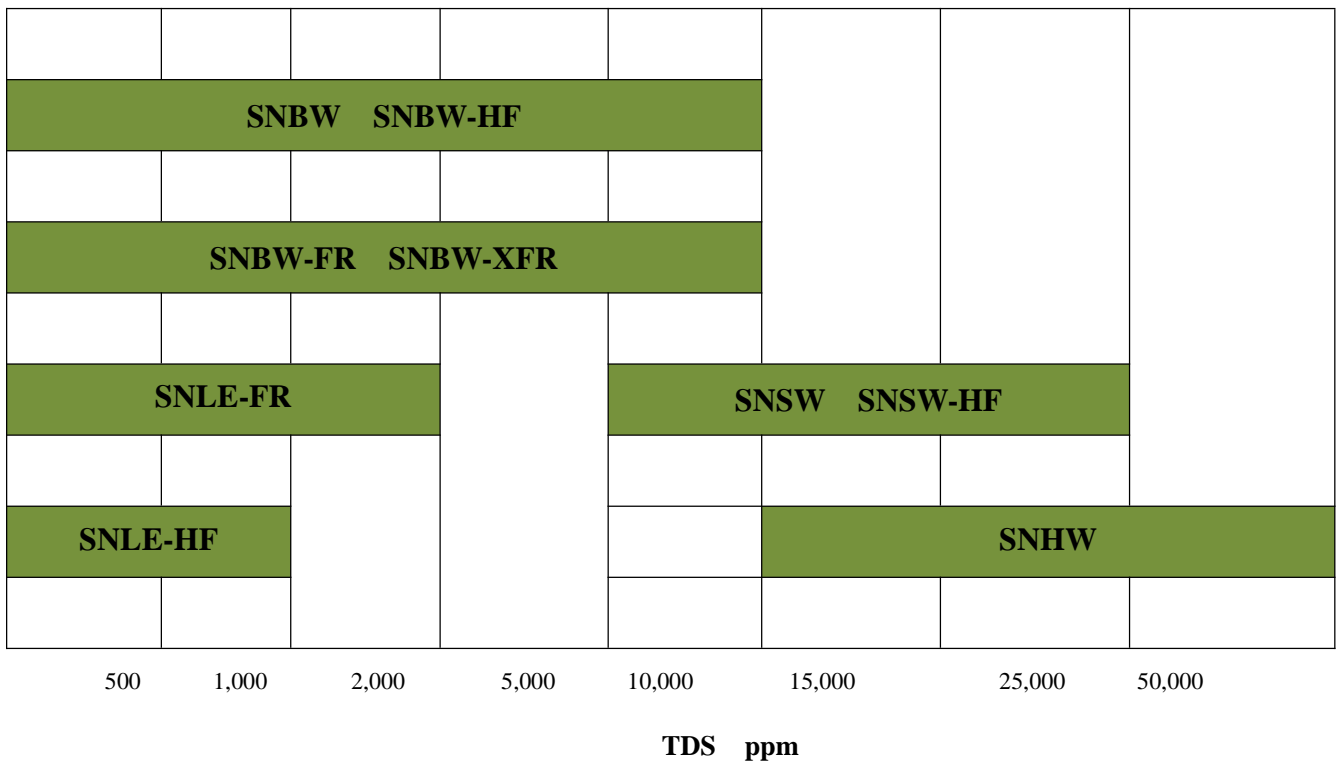
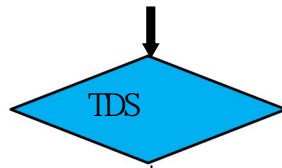



SINOMEMB®





• **SINOMEMB®**

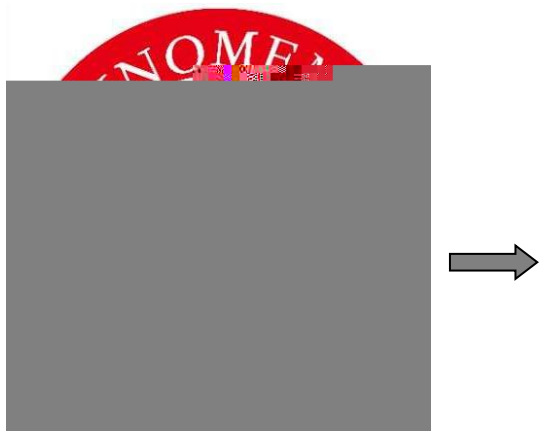



SINOMEMB®

SINOMEMB®

SNLE

SINOMEMB®

(SNLE)

HR

HF

10%

20%

SNLE

1000ppm

1.1

	ft² (m²)	GPD(m³/d)	(%)	(%)
SNLE-4040	90(8.4)	2600(10.3)	99.3	99.0
SNLE-4040-HR	90(8.4)	2300 (8.7)	99.5	99.0
SNLE-4021	38(3.5)	1000(3.8)	99.5	99.0
SNLE-8040	400(37.2)	12000(45.4)	99.5	99.0
SNLE-8040-440	440(41.0)	13500(51.1)	99.5	99.0



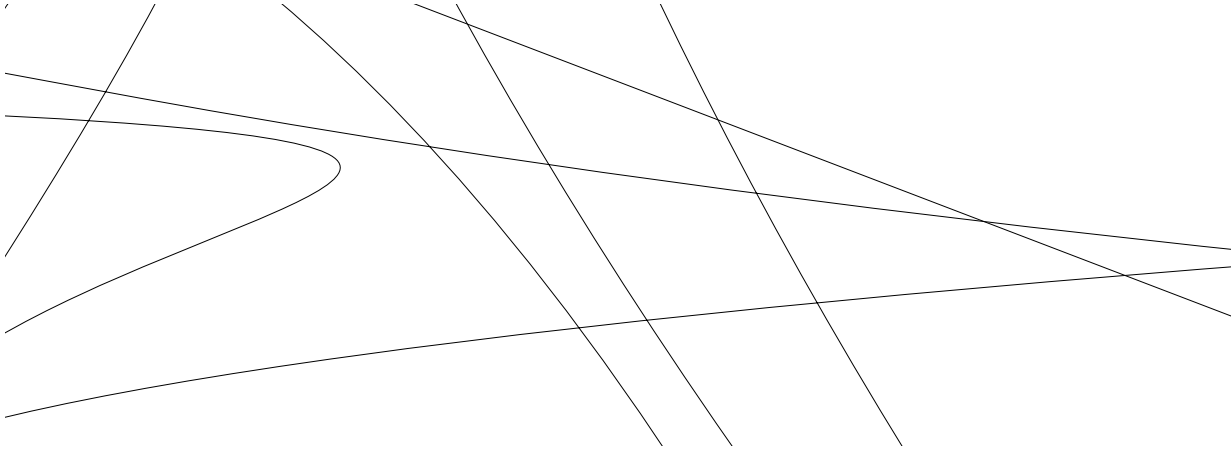

1.

2.

15%

3.

30-60

4.

5.

1

3

6.

30psi 0.21Mpa

7.

8.

1~1.5wt

()

(RO)

9.



SI NOMEMB®

SNBW

SINOMEMB®

SNBW-8040 SNBW-4040

2.1

SNIOMEMB®

SNBW

10000ppm

2.2

	ft ² (m ²)	GPD(m ³ /d)	(%)	(%)
SNBW-8040-400/34	400(37.2)	10500(39.8)	99.7	99.4
SNBW-HF400/34	400(37.2)	11500(43.5)	99.7	99.4
SNBW-8040	365(33.9)	9800(37.1)	99.7	99.4
SNBW-4040	90(8.4)	2400(9.1)	99.7	99.4

2.3

.....225psi (1.55Mpa)
25
 (NaCl).....2000ppm
 pH7.5
15%

2.4

.....600psi(4.14Mpa)
 4 16gpm(3.6 m³/h)





- 1.
2. 15%
3. 30-60
- 4.
5. 1 3
6. 50psi 0.34Mpa
- 7.
8. 1~1.5wt () (RO)
- 9.



SINOMEMB® SNBW-FR

SINOMEMB® (SNBW-FR) 34mil-56mil

3.1

SINOMEMB® (SNBW-FR) 10000ppm

3.2

	ft ² (m ²)	GPD(m ³ /d)	(%)	(%)
SNBW-8040-FR280/56	280(26)	7500(28.4)	99.5	99.3
SNBW-8040-FR330/48	330(30.7)	8500(32.2)	99.5	99.3
SNBW-8040-FR365/36	365(33.9)	9500(36.0)	99.7	99.4
SNBW-8040-FR400/34	400(37.2)	10500(39.7)	99.7	99.4
SNBW-4040-FR	90(8.4)	2200(8.3)	99.7	99.4

3.3

.....225psi (1.55Mpa)

.....25

(NaCl).....2000ppm

pH7.5

.....15%



3.4

		600psi(4.14Mpa)
4		16gpm(3.6 m ³ /h)
8		75gpm(17 m ³ /h)
		45
PH	10	35
		SDI ₁₅	5
		0.1ppm
		pH	2 11
		pH 30	1 13
		15psi(0.1Mpa)

3.5





- 1.
2. 15%
3. 30-60
- 4.
5. 1 3
6. 50psi 0.34Mpa
- 7.
8. 1~1.5wt () (RO)
- 9.



SINOMEMB®

SNBW-XFR

SINOMEMB®(SNBW-XFR)

34mil

SNBW-FR

4.1

SINOMEMB®(SNBW-XFR)

10000ppm

40%

4.2

	ft ² (m ²)	GPD(m ³ /d)	(%)	(%)
SNBW-XFR400/34	400(37.2)	11500(43.5)	99.75	99.4

4.3

.....225psi (1.55Mpa)

.....25

(NaCl).....2000ppm

pH8

.....15%

4.4

..... 600psi(4.14Mpa)

..... 75gpm(17 m³/h)



.....	45
PH 1035
SDI ₁₅	5
.....	0.1ppm
pH2 11
pH 301 13
.....	15psi(0.1Mpa)

4.5

- 1.
2. 15%
3. 30-60
- 4.
5. 1 3
6. 50psi 0.34Mpa
- 7.
8. 1~1.5wt () (RO)
- 9.



SINOMEMB®

SNBW-440Por

SINOMEMB®(SNBW-Por)

440ft²

f
MI



..... 0.1ppm

pH2 11

pH 301 13

.....15psi(0.1Mpa)

5.5

1.

2.

15%

3.

30-60

4.

5.



SINOMEMB®

SNHW

SINOMEMB®

(SNHW)

7000-20000ppm

TDS

6.1

	ft ² (m ²)	GPD(m ³ /d)	(%)	(%)
SNHW8040-FR400/34	400(37.2)	10500(39.7)	99.75	99.4

6.2

..... 435psi (3.0Mpa)
25
 (NaCl).....15000ppm
 pH8
10%

6.3

..... 1000psi(6.9Mpa)
 8040 75gpm(17 m³/h)
 45
 PH 1035
 SDI₁₅..... 5
 0.1ppm
 pH2 11
 pH 30 1 13
15psi(0.1Mpa)





SINOMEMB®

SNNF

SINOMEMB®

(SNNF)

270 90

270

90

- NF270 40 60% TOC THM
- NF90 90% TOC

7.1

SINOMEMB®270

TOC

THM

SINOMEMB®90

THM

7.2

	ft ² (m ²)		GPD(m ³ /d)	(%)
SNNF270-8040/34	400(37.2)	CaCl ₂	14700(55.6)	40 60
		MgSO ₄	12500(47.3)	97
SNNF90-8040/34	400(37.2)	NaCl	10000(37.9)	85 95
		MgSO ₄	10500(39.7)	97
SNNF270-4040	82(7.6)	CaCl ₂	4260 16.1	40 60
		MgSO ₄	3645 13.8	97
SNNF90-4040	82(7.6)	NaCl	2040(7.7)	85-95
		MgSO ₄	2700(10.0)	97

7.3



.....100 psi (0.69Mpa)

.....25

(NaCl).....2000ppm





- 1. 
- 2.  15%
- 3. 30-60
- 4.
- 5. 1 3
- 6. 50psi 0.34Mpa
- 7.
- 8. 1~1.5wt () (RO)
- 9.



SINOMEMB®

SNSW

SINOMEMB®

(SNSW)

8.1

SINOMEMB®

(SNSW)

20000ppm

8.2

	ft ² (m ²)	GPD(m ³ /d)	(%)	(%)	%
SNSW-2514	6.5 0.6	150 0.6	99.4	99.2	90
SNSW-2521	13 1.2	300 1.1	99.4	99.2	90
SNSW-2540	29 2.8	700 2.6	99.4	99.2	90
SNSW-4021	33 3.1	800 3.0	99.4	99.2	90
SNSW-4040	85(7.9)	1,950 7.4	99.75	99.6	91
SNSW-8040	380(35.6)	6000(22.7)	99.7	99.6	91
SNSW-8040-HF	400(37.2)	7500(28)	99.82	99.65	93

8.3

.....800psi (5.5Mpa)

.....25

.....32000ppm(NaCl) 5ppm

pH8

.....2% 2514 8%(2540 4040 8040) 4%(2521 4021)



8.4

8 41200psi(8.3Mpa)

2.51000psi(6.9Mpa)

875gpm(17 m3/h)

416gpm(3.6 m3/h)

2.56gpm(1.4 m3/h)

.....45

PH 1035

SDI15.....5

..... 0.1ppm

pH2 11

pH 301 13

.....15psi(0.1Mpa) (2540 2514 4021 4040 2521 8040)

.....13psi(0.9Mpa) (8040HF)

8.5

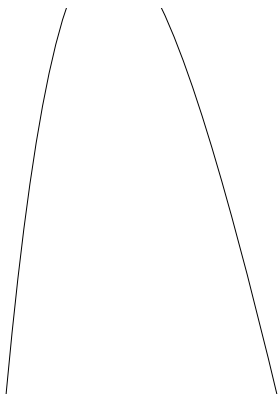



1.

2.

15%

3.

30-60

4.

5.

1

3

6.

50psi 0.34Mpa

7.

8.

1~1.5wt

()

(RO)

9.



SINOMEMB®

SNLE

1.1

SNIOMEMB®

SNLE

1000ppm

800

1.2

	(%)	GPD (m³/d)			
			psi(MPa)	(ppm)	(%)
SNLE-3213-600	95.0	600(2.3)	100(0.7)	250 NaCl	15
SNLE-3313-800	95.0	800(3.0)	100(0.7)	250 NaCl	15
SNLE-4013-1000	95.0	1000(3.8)	100(0.7)	250 NaCl	15
SNLE-2812-200	97.0	200(0.8)	100(0.7)	250 NaCl	15
SNLE-3012-300	97.0	300(1.2)	100(0.7)	250 NaCl	15
SNLE-3012-400	97.0	400(1.6)	100(0.7)	250 NaCl	15
SNLE-3013-400	97.0	400(1.6)	100(0.7)	250 NaCl	15
SNLE-3013-600	96.0	600(2.3)	100(0.7)	250 NaCl	15
SNLE -2521	99	300 (1.13)	150(1.05)	250 NaCl	8%
SNLE -2540	99	750 (2.84)	150(1.05)	250 NaCl	8%

()



1.3

.....	25
pH	7.5

1.4

2.5	600psi(4.1Mpa)
	150psi(1.03Mpa)
3213 3313	4.0gpm(15lpm)
3012 3013 2812	2.5gpm(9.5lpm)
4013	16gpm(3.6m ³ /h)
2.5	6gpm(1.4m ³ /h)
	45
PH 10	35
SDI ₁₅		



1.5

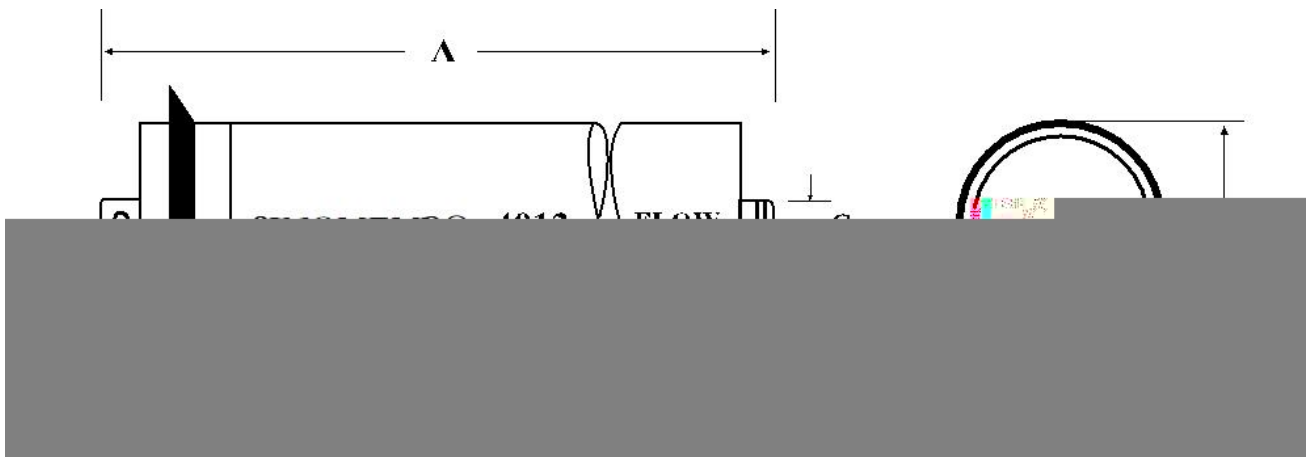
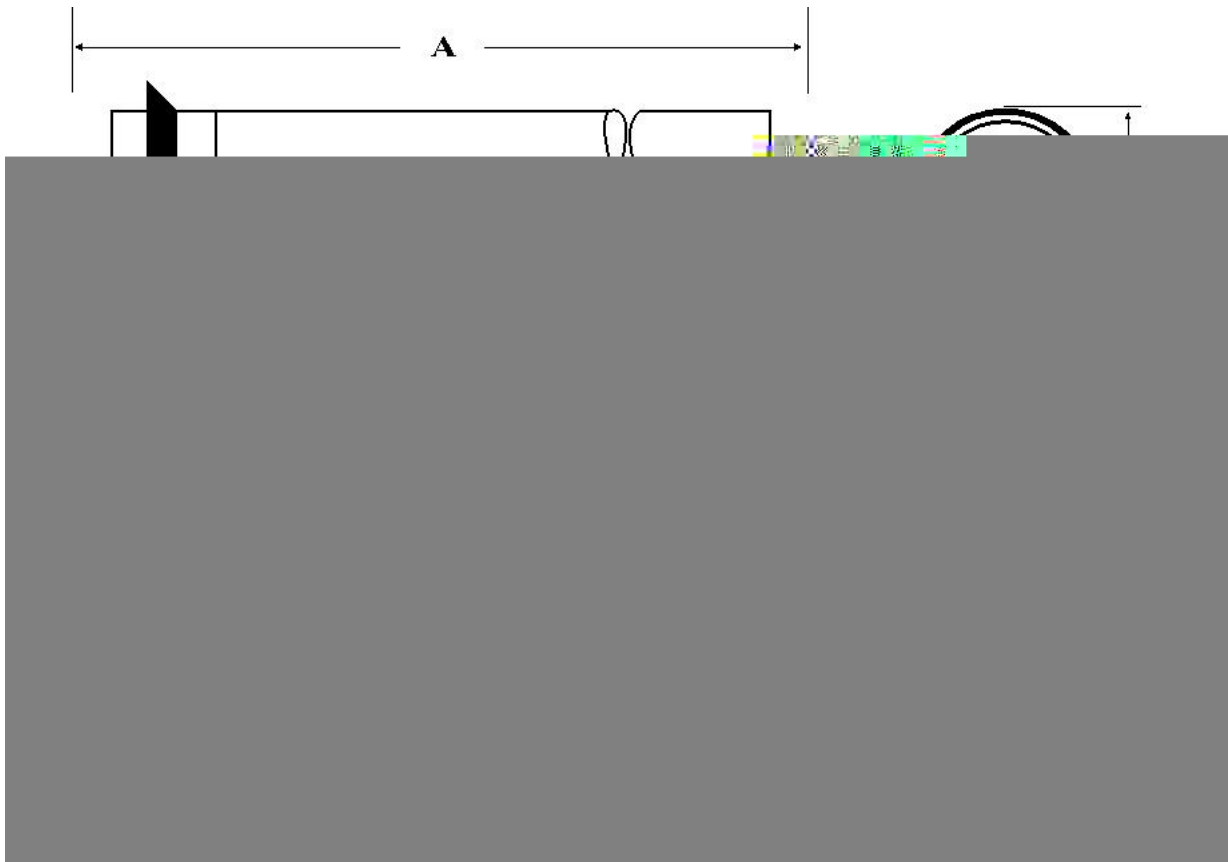



- 1.
2. 15%
3. 30-60
- 4.
5. 1 3
6. 30psi 2.1bar
- 7.
8. 1~1.5wt () (RO)
- 9.



SINOMEMB®

SNSE

SINOMEMB®

SNSE

4 4021 0.7mpa 2812 3013 36psi

500ppm

2.1

	(%)	GPD (m³/d)			
			psi(MPa)	(ppm)	(%)
SNSE-4040	99.0	2500 (9.5)	114(0.8)	1000 NaCl	15
SNSE-4021	98.0	1000 (3.8)	114(0.8)	1000 NaCl	8
SNSE-2812	93.0	125(0.3)	36(0.25)	250 NaCl	15
SNSE-3013	93.0	350(1.33)	36(0.25)	250 NaCl	15

()

2.2

.....100psi (0.7Mpa)/36psi(0.25)

.....25

(NaCl).....1000ppm/250ppm

pH7.5

.....15% 8%(4021)

2.3

.....300psi(2.07Mpa) 2812 3013

..... 600psi(4.14Mpa) 4021 4040

.....16gpm(3.6 m³/h) 4021 4040

.....2lpm(3.6 m³/h) 2812



.....2.5gpm(9.5lpm) 3013

..... .45

PH 1035

SDI₁₅.....5

..... 0.1ppm

pH 2 11

pH 30 1 13

2.813psi(0.09Mpa)

301310psi(0.07Mpa)

415psi(0.1Mpa)

2.4

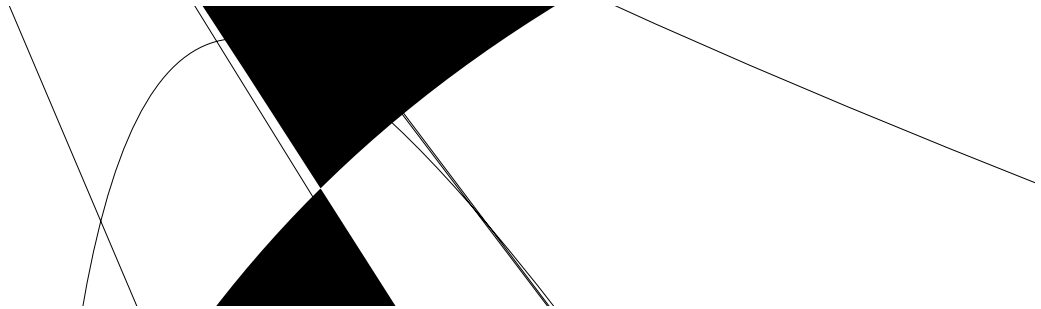



6. 30psi 2.1bar

7.

8. 1~1.5wt () (RO)

9.



SINOMEMB® SNLE

SINOMEMB®

36psi

3.1

-
-
-
-

TDS

QC

3.2

	(%)	GPD (m ³ /d)			
			psi(MPa)	(ppm)	(%)
SNLE-1810-50	97.0	50(0.2)	60(0.4)	250 NaCl	15
SNLE-1812-50	97.0	50(0.2)	60(0.4)	250 NaCl	15
SNLE-1812-75-HR	98.0	75(0.28)	60(0.4)	250 NaCl	15
SNLE-1812-75	97.0	75(0.28)	60(0.4)	250 NaCl	15
SNLE-1812-100	96	100(0.4)	60(0.4)	250 NaCl	40
SNLE-1812-150	96	150(0.6)	60(0.4)	250 NaCl	40
SNSE-1812	93.0	60(0.23)	36(0.25)	250 NaCl	15

()

3.3

..... 25

pH 7.5

3.4

.....150psi(1.03Mpa)

.....2.0gpm(7.6lpm)



..... 45

PH 1035

SDI₁₅.....5

..... 0.1ppm

pH 2 11

pH 301 13

.....10psi(0.07Mpa)

3.5

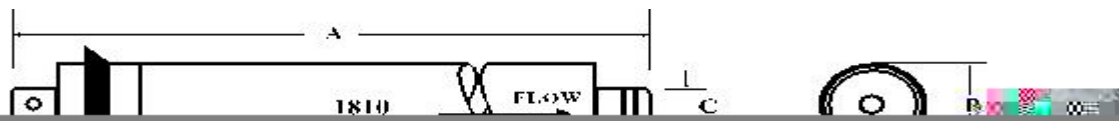

- 1.
2. 15%
3. 30-60
- 4.
5. 1 3
6. 30psi 2.1bar
- 7.
8. 1~1.5wt () (RO)



9.

3.1

1748

Abbe Nollet

Henri Dutrochet 1827

Osmosis

Abbe Nollet

1854

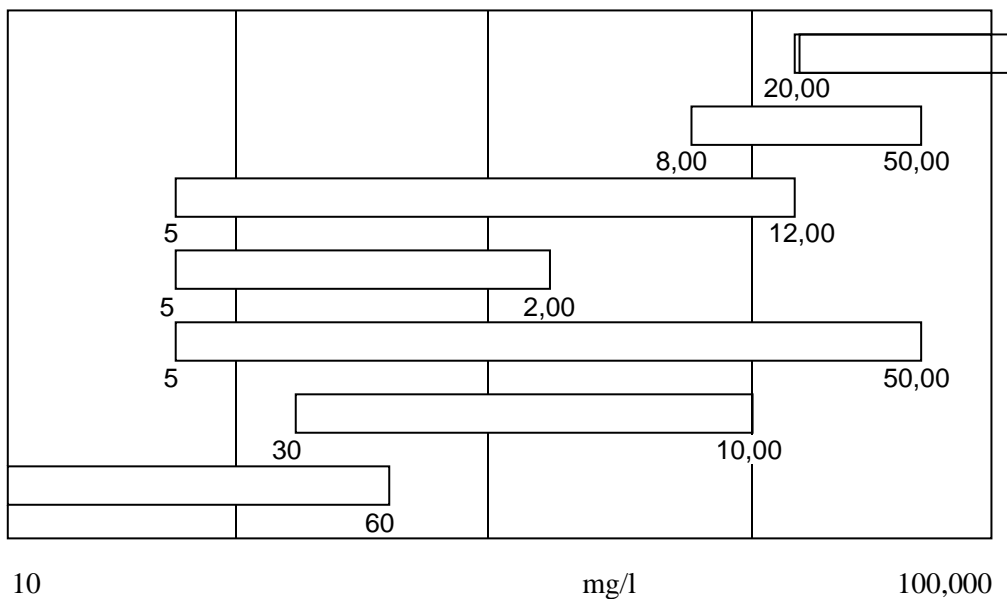

(MF) (UF) (NF) (RO)

(1) (MF)

0.1~1

(2) (UF)

0.005~0.1

500~100 000

(3) (NF)

1nm

50~100

20~99%

60~99%

20~60%

(4) (RO)

98%



3.3

()

()

()

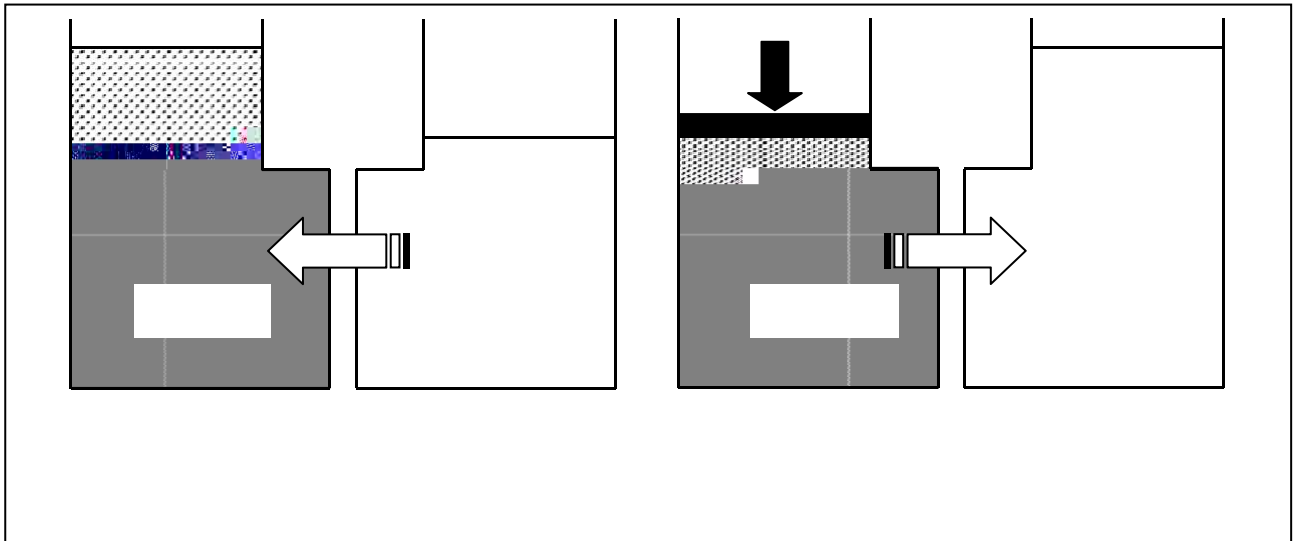

3.1

3.4



pH

(1)

(2)

1 2.5%-3.0% (25)

(3)

(4)





- ❖ TDS 5,000~15,000mg/L
- ❖ TDS 35,000mg/L

4.1

Na⁺ Cl⁻

4.1

<p>_____</p> <p>_____</p> <p>_____</p> <p>_____</p>			
		()	
(SDI ₁₅)			
(NTU)		pH	
(Ca ²⁺)		(Cl ⁻)	
(Mg ²⁺)		(SO ₄ ²⁻)	
(Na ⁺)		(CO ₃ ²⁻)	
(Ba ²⁺)		(HCO ₃ ⁻)	
(Sr ²⁺)		(PO ₄ ³⁻)	
(K ⁺)		(F ⁻)	
(Fe ²⁺)		(NO ₃ ⁻)	
(Fe ³⁺)		(SiO ₂)	
(Al ³⁺)		()	
TDS (ppm)		BOD ₅ (ppm)	



(SS)		TOC(ppm)	
(CaCO ₃ ppm)		CODcr(ppm)	
(mmol/L)		(/mL)	
(mmol/L)		(ppm)	

Ba² Sr² 1μg/L(ppb) 1mg/L(ppm)

RO/NF

RO/NF

4.2

4.2

1	NTU	<1	0.2		
2	/ml	<100	5um	RO	
3	SDI ₁₅	<5	3		
4	PH	3--10	6.5-8.3		
5		5-45	25	38	
6	ppm	<0.1			
7	ppm				



8 COD ppm <10

9 BOD ppm <5 2

10 TOC ppm <3 2

11 /ml <1

12 %

13 H₂S ppm <0.1

14 % <10

15 Fe³⁺ ug/L



	CuCl ₂	1.2×10 ⁻⁶	5.92		Fe(OH) ₃	1.1×10 ⁻³⁶	35.96
	MgCO ₃	3.5×10 ⁻⁸	7.46		FePO ₄	1.3×10 ⁻²²	21.89
	MgF ₂	6.4×10 ⁻⁹	8.19		PbSO ₄	1.6×10 ⁻⁸	7.80
	Mg(OH) ₂	1.2×10 ⁻¹¹	10.92		SrCO ₃	1.1×10 ⁻¹⁰	9.96
	MgNH ₄ PO ₄	2.0×10 ⁻¹³	12.70		SrSO ₄	3.2×10 ⁻⁷	6.49
	MnCO ₃	1.8×10 ⁻¹¹	10.74		SrF ₂	2.4×10 ⁻⁹	8.61
	Mn(OH) ₂	4.0×10 ⁻¹⁴	13.40		Al(OH) ₃	2.0×10 ⁻³³	32.70

4.3.2

(1)

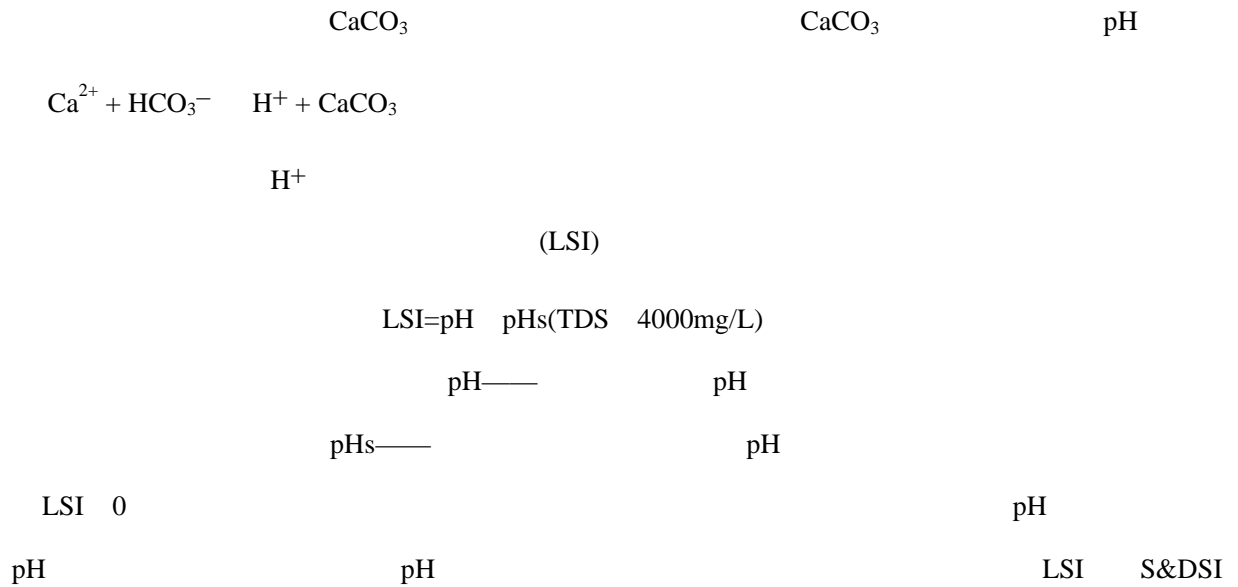

(2)





30~45%

35%

(3)

	Na ⁺	Ca ²⁺ Ba ²⁺ Sr ²⁺
NaCl		pH
	Ca ²⁺ Ba ²⁺ Sr ²⁺	99.5%

		Ca ²⁺ Ba ²⁺ Sr ²⁺ H ⁺
pH	4~5	pH 4.2

(4)

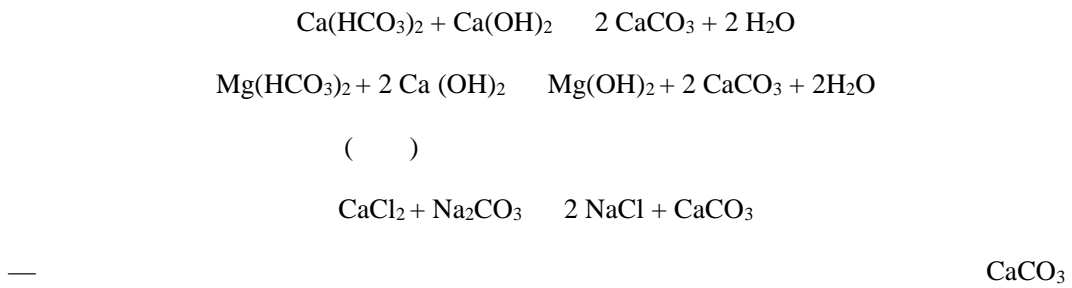

RO/NF

pH

200m³/hr

4.4

(SDI Silting Density Index)

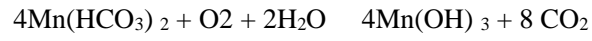

	pH				SDI
5 RO	0.1mg/L				FeCO ₃
	Fe ²⁺				
				pH	Fe ²⁺
					pH<6
<0.5mg/L	Fe ²⁺	4mg/L	Cl ₂	KMnO ₄	



4.5

4.5.1

1~3 m



“Robbin

”



润泽天下 中国良芯
Nourishing The World With Pure Water

2022



5.1

RO

NF

90%

45%

(1)

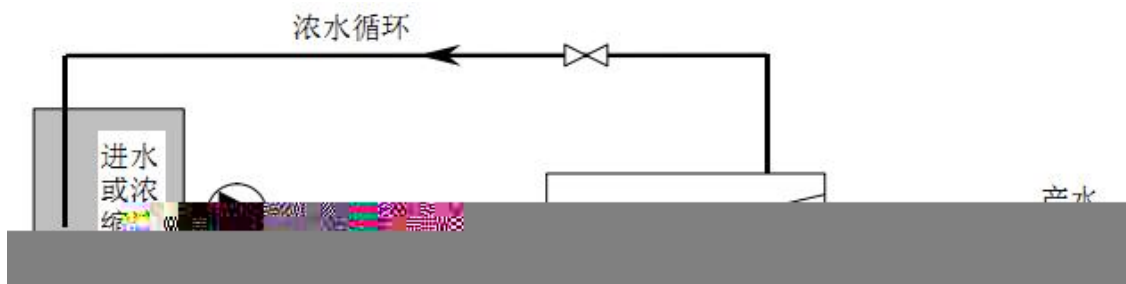

(2)

RO/NF

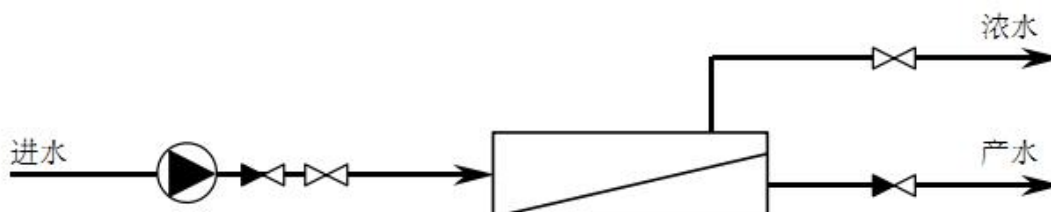



5.2

5.2.1

8 40

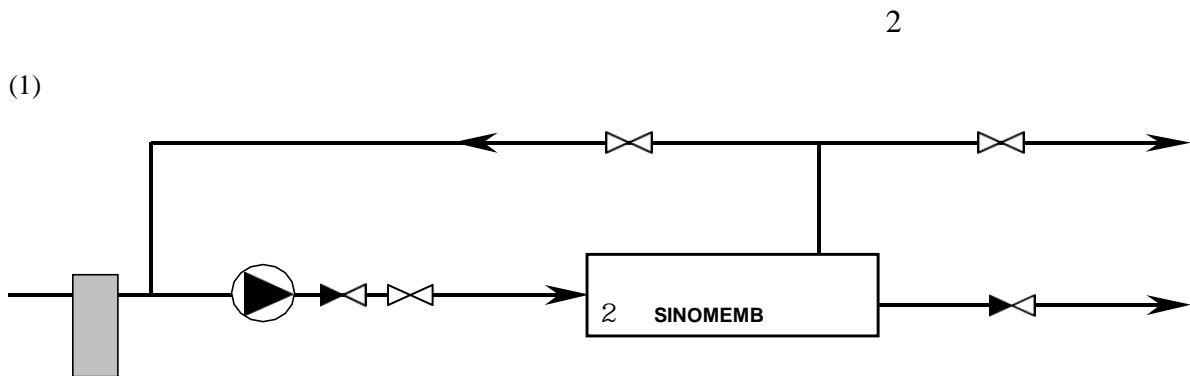

0.3bar

0.3bar

0.3~2 bar



- ❖
- ❖
- ❖

5.2.2

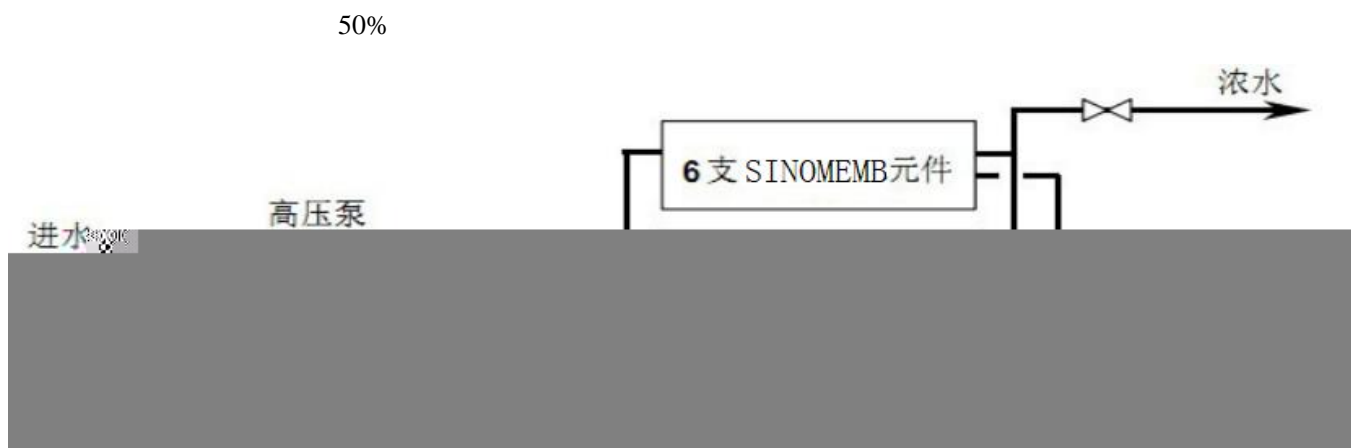

5.2.3

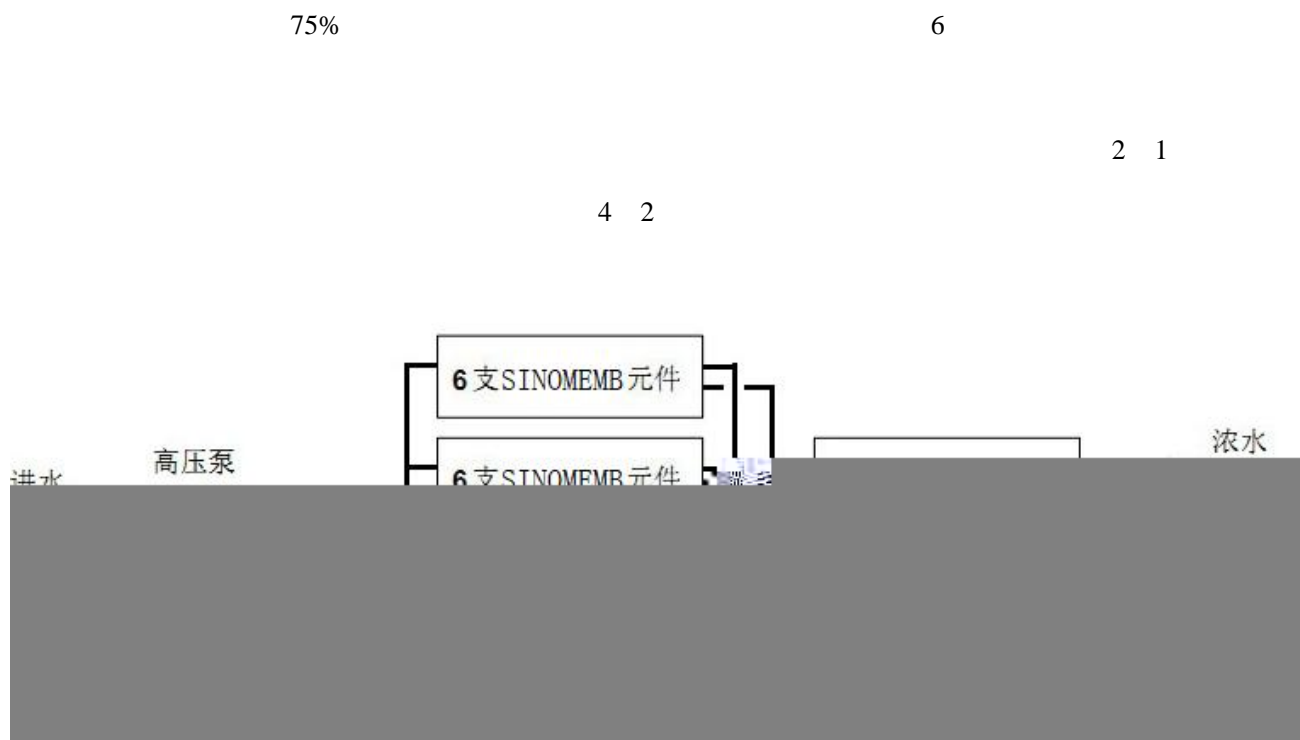

5.2.4

RO/NF



5-3

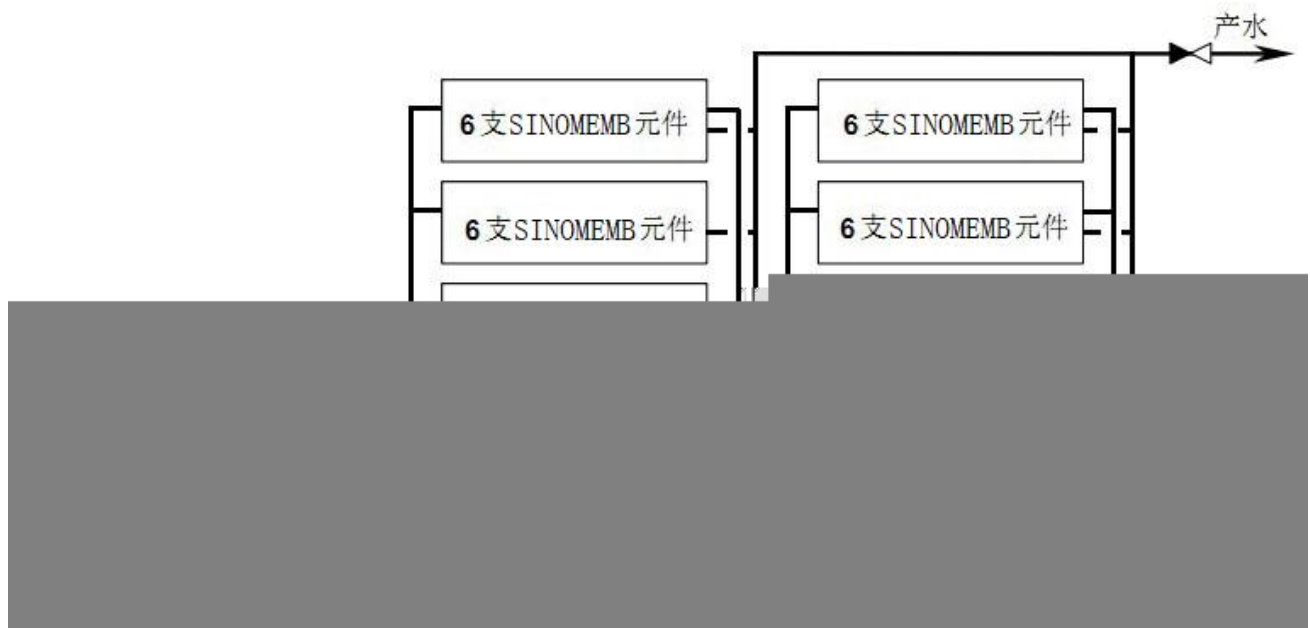

5.2.5

RO/NF

RO/NF

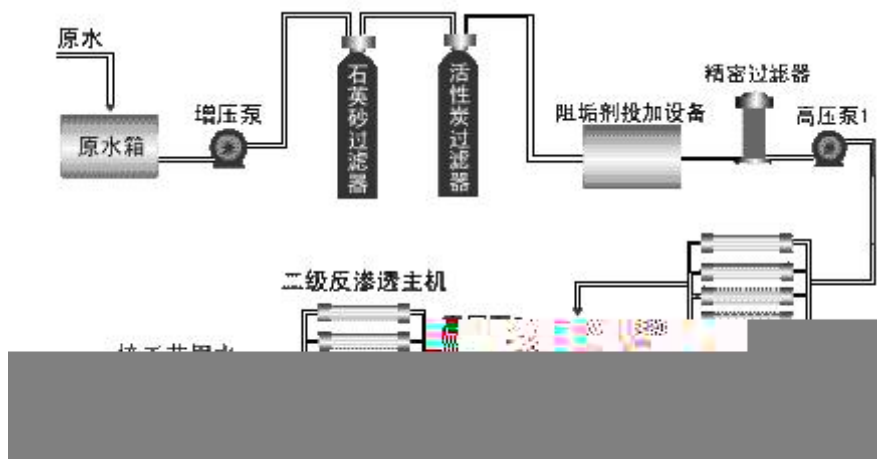

() 0.3bar

RO

CO₂

pH

8.2

CO₂

pH

CO₂

NaOH

NaOH

pH

5.2.6

(1)

(2)

(3)

(4)

(5)



5.3

RO

RO

5.3.1

5.1

5.1

	NTU	<1	0.2
SDI ₁₅		<5	3
	/ml	<100	5um RO
	/ml		<1
Fe ³⁺	ug/L	>5ppm	<50
	ug/L		<50
Al	ug/L		<50
TOC	ppm	<5	3
COD	ppm		<10
BOD	ppm	<5	2
H ₂ S	ppm		<0.1
	%		<10
	ppm		<0.1
	ppm		0
CaCO ₃			LSI<0
CaSO ₄	%		<230
BaSO ₄	%		<6000



SrSO ₄	%	<800	
CaF ₂	ppm	<1.7	
CaPO ₄			
SiO ₂	%	<100	20ppm
PH		3--10	6.5-8.3
		5-45	25
	ppm	50ppm	PH 5
/	ppm		

5.3.2

RO/NF

RO/NF

5.3.3

10gpm 2.3m³/h 8 40

SINOMEMB

RO/NF

5.3.4

f (gfd L/m²h)



5.5.5

- ❖
- ❖
- ❖
- ❖
- ❖
- ❖
- ❖

()

5.5.6

RO/NF

- 1
- 2
- 3
- 4
- 5
- 6
- 7

pH



5.6

RO/NF

PVC U-PVC ABS



6.1

6.1.1

SINOMEMB

(6mm)

(1)

50%

(2)

30

(3)

(4)

50%

5

6

6.1.2

1

Y

(Y

)

(2)





10cm

(3)

“O”

“O”

(4)

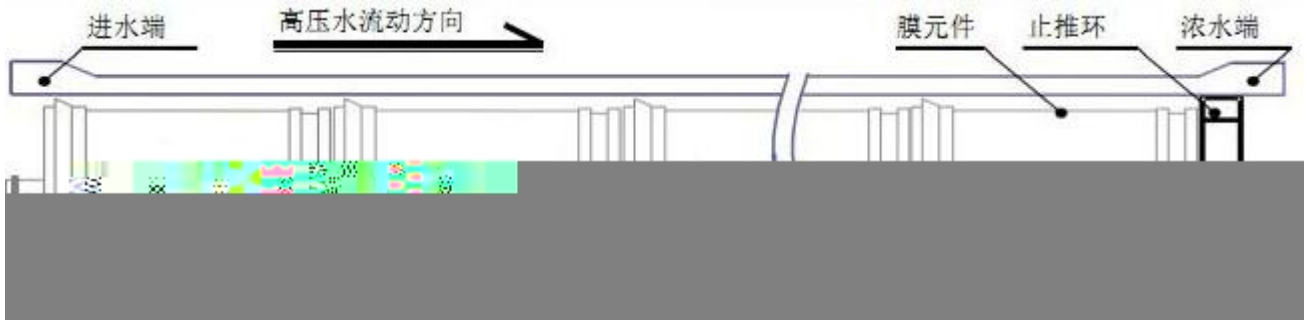

(5)

6-3

(6)

(7)

(8)

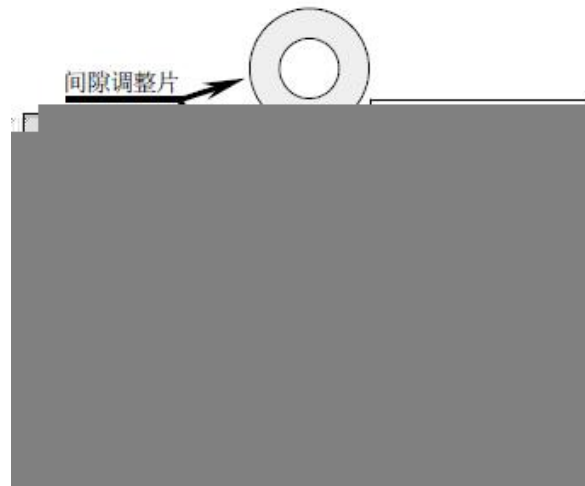

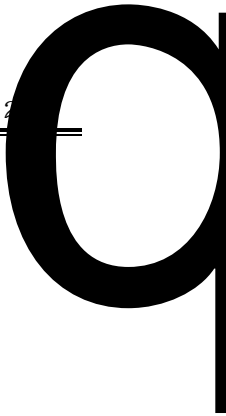

6.1.3

- (1)
- (2)
- (3)

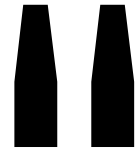

6.2

6.2.1

RO NF

6.2.2

RO

- ❖
- ❖
- ❖
- ❖
- ❖
- ❖
- ❖
- ❖
- ❖
- ❖



(1)

(2) /

(3) (0.2~0.4MPa 2 0.2-0.3Mpa
) 4 0.6~3.0 m³/h 8
 2.4~12.0 m³/h 50%

(4)

(5) 30 6
 3 8 2



(6) ()

(7)

(8)

(9)

0.07MPa

(10)

(11) ()

pH

4

30%

(12)

(LSI)

(S&DSI)

pH



(13)

“O”

(14)

(15) 1-2

(16)

(17) 24-48

(18)

(19) 16) ~18)

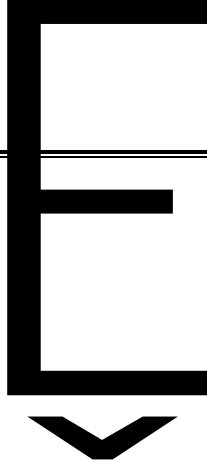

6.2.4

)

(

6.2.5

RO/NF

6.2.5.1

(1)

RO/NF

RO/NF

(2)



(1)

(2)

(3) 3

(4)

6.2.5.3

()

(1)

(2) ()

(3) pH SDI

(4)

6.2.6

3.0bar 43.5psi

SDI

8.5L/m2.h 5GFD

0.3bar 4.35psi



◇

◇

24

◇

24

24

48

6.2.7

(1)

(2)

(3) RO

(4)

(5)

(6)

pH

6.3

5

6.3.1

5 30

1

2

3 5

6.3.2

➤

1

2 RO

3 1wt% 20wt%

4 RO 15-20



➤

30

1

2

●

20 1wt%

●

20 1wt% 20wt%

3

5-10

0.5-1

5-10

4

●

30 PH pH 3

●

30

●

20 PH 90

●

20 PH 60

5

1

5-10

6

0 ~35 -4

6.3.3

(1)

(2)

(3)

(4)





润泽天下 中国良芯
Nourishing The World With Pure Water



3

1

2

①

②

③

④

⑤

1/4

4



7

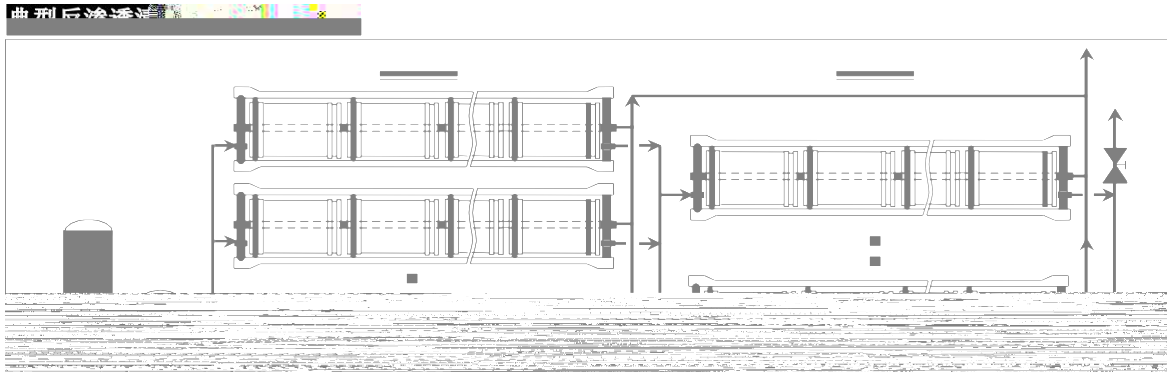

10μm

FI

PI

PI

PI

TI

7.3

SINOMEMB

pH



15%



15%



10%

48



7.4

7.4.1

7.4.1.1

7.4.1.2

7.4.2



7.5



GB 8978

7.6

7.6.1

7.6.1.1



a RO

b

c

d) SDI

e ,

f RO

g

h

i

j

k

l

m

n

o

7.6.1.2

1

	SDI	



	SDI		
	SDI		
		—/	/
		—/	/
		—/	/
		—/	/
		—/	

7.6.1.3

- “O”
-
-
-
-
-
-
-
-
-



7.7

7.7.1

	0.2%	45 pH>2	
	0.5%	45	
	2.0%	45 pH 3.0	
	0.1% 1.0%EDTA	30 pH 12	
	0.1% 0.025%	30 pH 12	
	1.0%		
	0.5%	30 pH>2	
	2.0%	30 pH 3.0	
	0.1% 0.025%	30 pH 12	
	0.1% 0.025% 0.2%	30 12 pH>2	NaOH HCl
	0.1% 1.0%EDTA 0.2%	30 pH 12 pH>2	NaOH EDTA HCl
	0.1% 0.025%	30 pH 12	
	0.1%	30 pH 12	

7.7.2



7.7.3

7.7.3.1

a

b

c

7.8

7.8.1

7.8.1.1

a) pH 2 12

FRP

b)

c)

d)

e



b)

c

0.4MPa

7.8.1.4



7.8.1.5

a)

b)

7.9.1.6

a

b

c

d

e

f

1m/s

3m/s

7.8.1.7

a

b

c

d

7.8.1.8

7.9

7.9.1



7.9.3 RO

RO

15

7.9.4

7.9.5

7.9.6

7.9.7

30nin

7.9.8

1h

10h

7.9.9

1

7.10.10

pH

7.9.11

20

7.9.12

a

pH

b

c

7.10.4 7.10.10



d

e



7.10.3

SINOMEMB

25°C

7.10.4

SINOMEMB

1ppm

200~1000

pH

pH

-T N-

N-chloroisocyanurate

SINOMEMB



8.1

TDS

8.2

8.2.1

(1)



(3)

(4)

1)

2)

3)

(5)

(6)

(7)

(8)

TDS

CO₂

(9)

(10)

(11) SDI

SDI

<5 <3

(12)

8.2.4

(1)

“ ”

“O”



(2)

SINOMEMB

(3)

SINOMEMB

(4)

50%



8.3

1

2

3

8.3.1

1

pH12~13

FR

2

❖

❖

❖

3

/



润泽天下 中国良芯
Nourishing The World With Pure Water



8.3.3

8

3.5bar

1bar

8

8

1

2

3

4

5

6





				KMnO ₄	
			O		O

/



SINOMEMB®

9.1

SINOMEMB®

9.1.1



1) 2—6 180

2) 6 30

3) 12

4) 24

5) ,4

48 24

6)

“ ”



SINOMEMB®

TFC

20~25

	TCF		TCF		TCF		TCF		TCF
5.0	2.072	12.2	1.575	19.4	1.214	26.6	0.956	33.8	0.786
5.1	2.064	12.3	1.552	19.5	1.210	26.7	0.954	33.9	0.784
5.2	2.056	12.4	1.564	19.6	1.206	26.8	0.951	34.0	0.782
5.3	2.048	12.5	1.558	19.7	1.201	26.9	0.948	34.1	0.780
5.4	2.040	12.6	1.552	19.8	1.197	27.0	0.946	34.2	0.778
5.5	2.032	12.7	1.547	19.9	1.193	27.1	0.943	34.3	0.776
5.6	2.024	12.8	1.541	20.0	1.189	27.2	0.940	34.4	0.774
5.7	2.016	12.9	1.535	20.1	1.184	27.3	0.938	34.5	0.772
5.8	2.009	13.0	1.529	20.2	1.180	27.4	0.935	34.6	0.770
5.9	2.001	13.1	1.524	20.3	1.176	27.5	0.933	34.7	0.768
6.0	1.993	13.2	1.518	20.4	1.172	27.6	0.930	34.8	0.766
6.1	1.985	13.3	1.513	20.5	1.168	27.7	0.927	34.9	0.764
6.2	1.978	13.4	1.507	20.6	1.164	27.8	0.925	35.0	0.762
6.3	1.970	13.5	1.502	20.7	1.160	27.9	0.922	35.1	0.760
6.4	1.962	13.6	1.496	20.8	1.156	28.0	0.920	35.2	0.758
6.5	1.955	13.7	1.491	20.9	1.152	28.1	0.917	35.3	0.756
6.6	1.947	13.8	1.485	21.0	1.148	28.2	0.915	35.4	0.754
6.7	1.940	13.9	1.480	21.1	1.144	28.3	0.912	35.5	0.752
6.8	1.932	14.0	1.474	21.2	1.140	28.4	0.910	35.6	0.750
6.9	1.925	14.1	1.469	21.3	1.136	28.5	0.907	35.7	0.748



7.0	1.918	14.2	1.464	21.4	1.132	28.6	0.905	35.8	0.746
7.1	1.910	14.3	1.458						



9.9	1.717	17.1	1.285	24.3	1.024	31.5	0.836	38.7	0.692
10.0	1.711	17.2	1.280	24.4	1.021	31.6	0.834	38.8	0.690
10.1	1.704	17.3	1.276	24.5	1.017	31.7	0.832	38.9	0.688
10.2	1.698	17.4	1.271	24.6	1.014	31.8	0.829	39.0	0.686
10.3	1.691	17.5	1.267	24.7	1.010	31.9	0.827	39.1	0.685
10.4	1.685	17.6	1.262	24.8	1.007	32.0	0.825	39.2	0.683
10.5	1.679	17.7	1.258	24.9	1.003	32.1	0.823	39.3	0.681
10.6	1.672	17.8	1.253	25.0	1.000	32.2	0.820	39.4	0.679
10.7	1.666	17.9	1.249	25.1	0.997	32.3	0.818	39.5	0.678
10.8	1.660	18.0	1.244	25.2	0.994	32.4	0.816	39.6	0.676
10.9	1.654	18.1	1.240	25.3	0.992	32.5	0.814	39.7	0.674
11.0	1.647	18.2	1.236	25.4	0.989	32.6	0.812	39.8	0.672
11.1	1.641	18.3	1.231	25.5	0.986	32.7	0.810	39.9	0.671
11.2	1.635	18.4	1.227	25.6	0.983	32.8	0.807	40.0	0.669
11.3	1.629	18.5	1.223	25.7	0.981	32.9	0.805		
11.4	1.623	18.6	1.218	25.8	0.978	33.0	0.803		
11.5	1.617	18.7	1.290	25.9	0.975	33.1	0.801		
11.6	1.611	18.8	1.285	26.0	0.972	33.2	0.799		
11.7	1.605	18.9	1.280	26.1	0.970	33.3	0.797		
11.8	1.599	19.0	1.276	26.2	0.967	33.4	0.795		
11.9	1.593	19.1	1.271	26.3	0.964	33.5	0.792		
12.0	1.587	19.2	1.267	26.4	0.962	33.6	0.790		
12.1	1.581	19.3	1.262	26.5	0.959	33.7	0.788		